

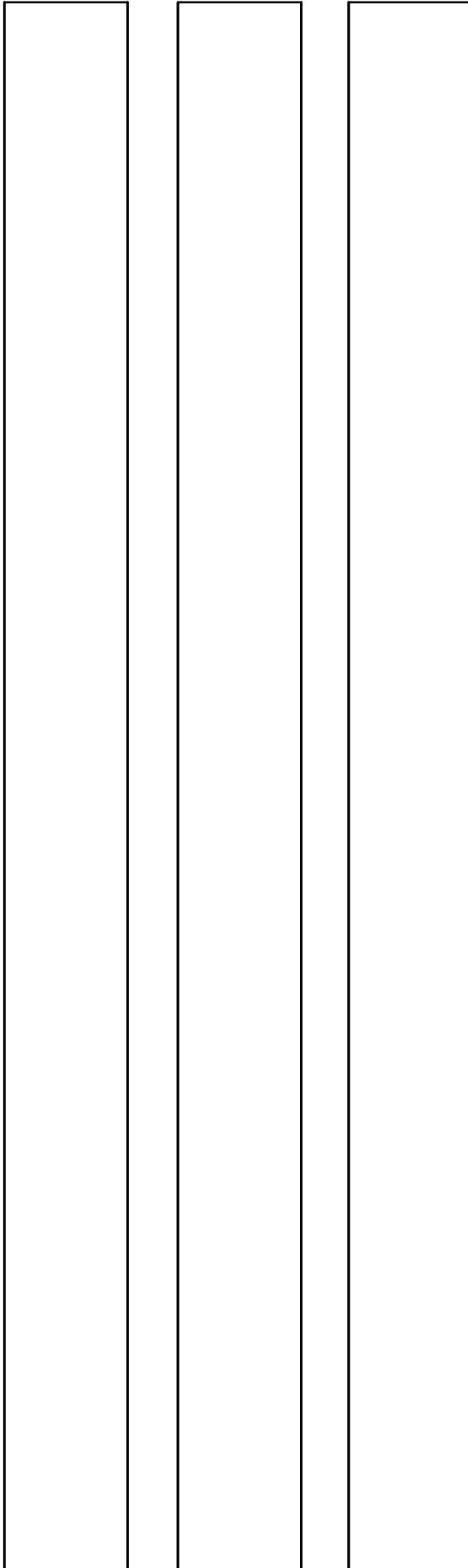

RESTRAP

TECHNICAL BIKEPACKING GEAR



• Print this document on A4 paper (21x29.7cm) making sure that it is at 100% scale.

• Measure both sides of the crossed needles to verify the scale is accurate.

• Assemble the prints according to the numbered guide on each sheet, ensuring the registration marks lay on top of each other.

• Tape the sheets together, then cut along the bag's outline for a physical representation of our bag's shape and size.

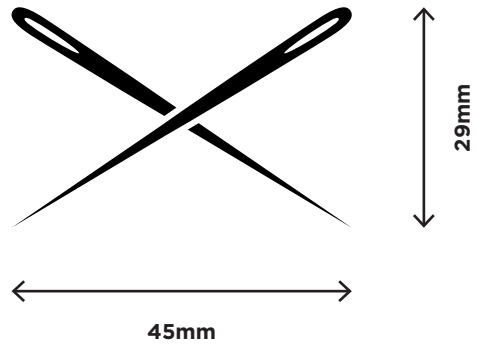

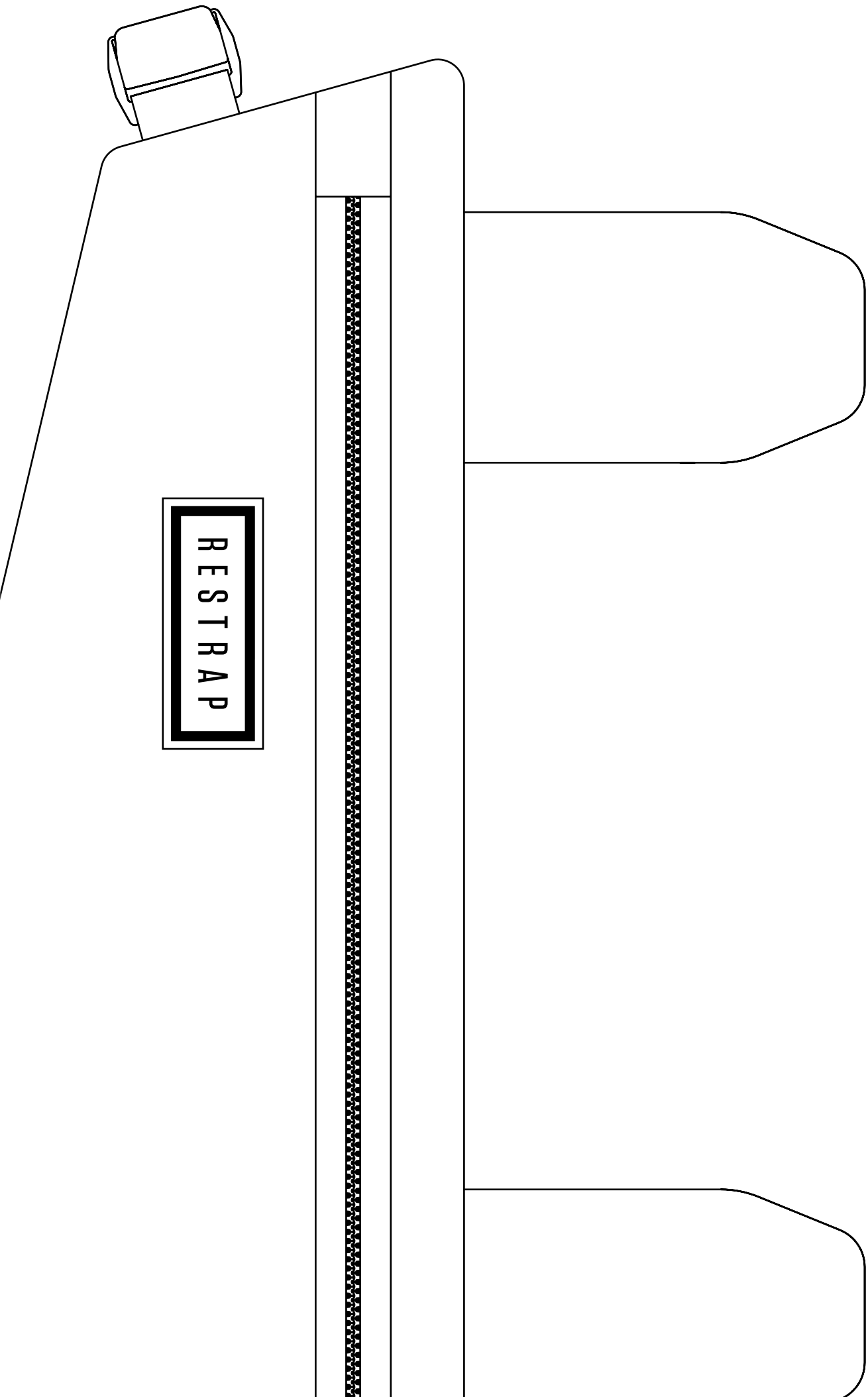



NUMBER GUIDE

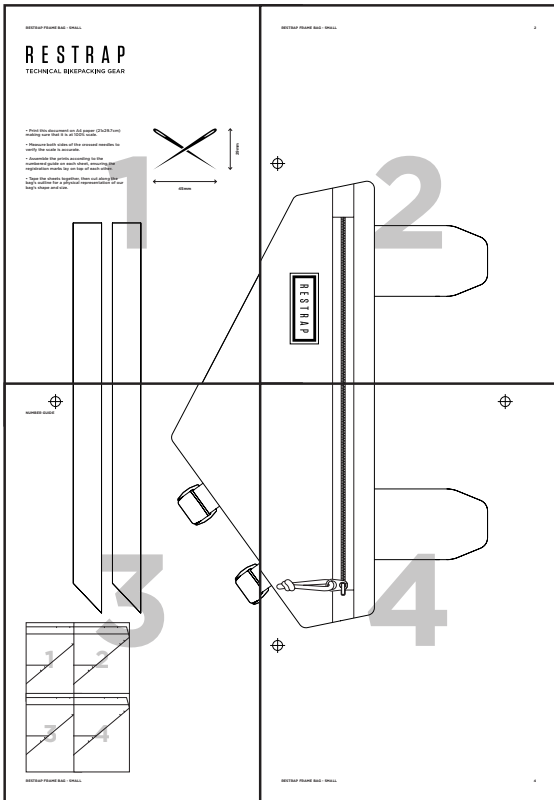
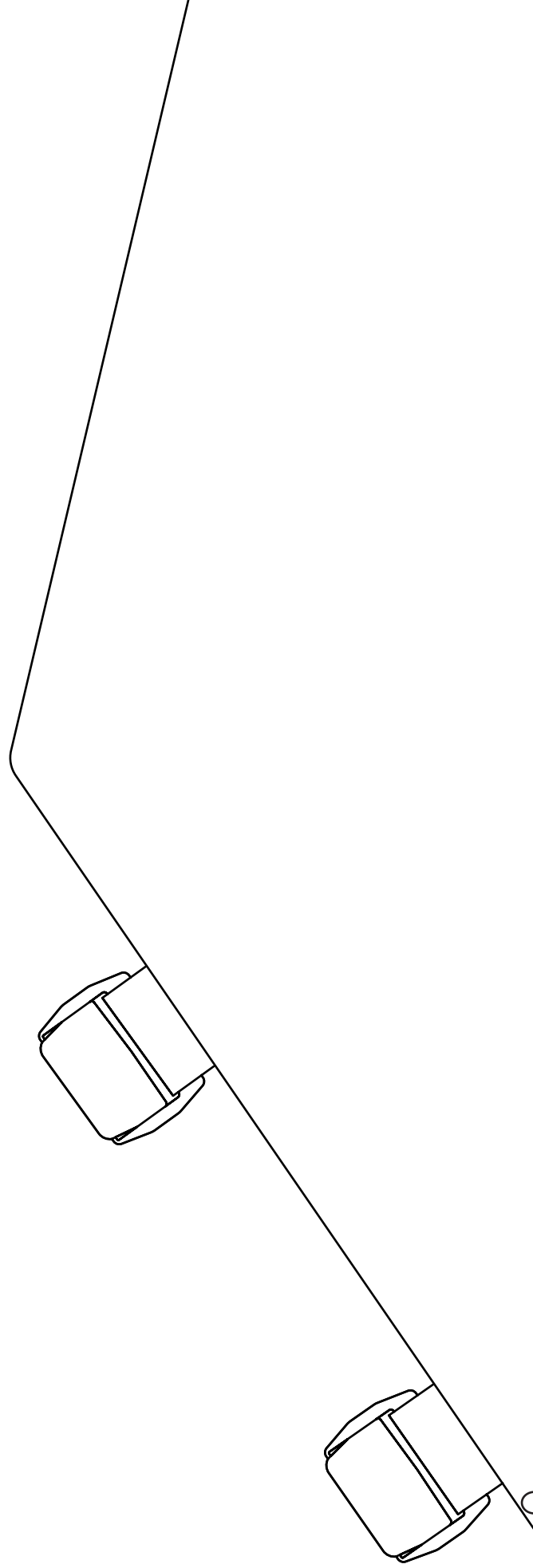
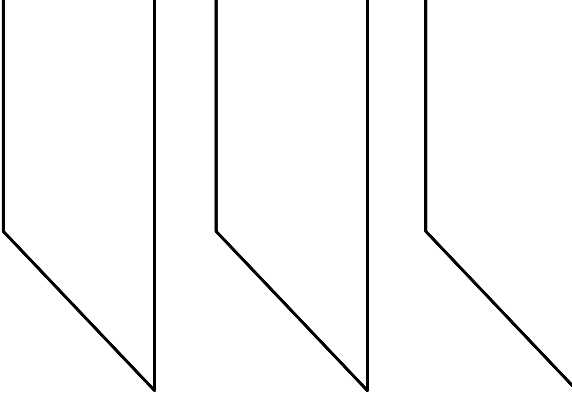

RESTRAP FRAME BAG - LARGE



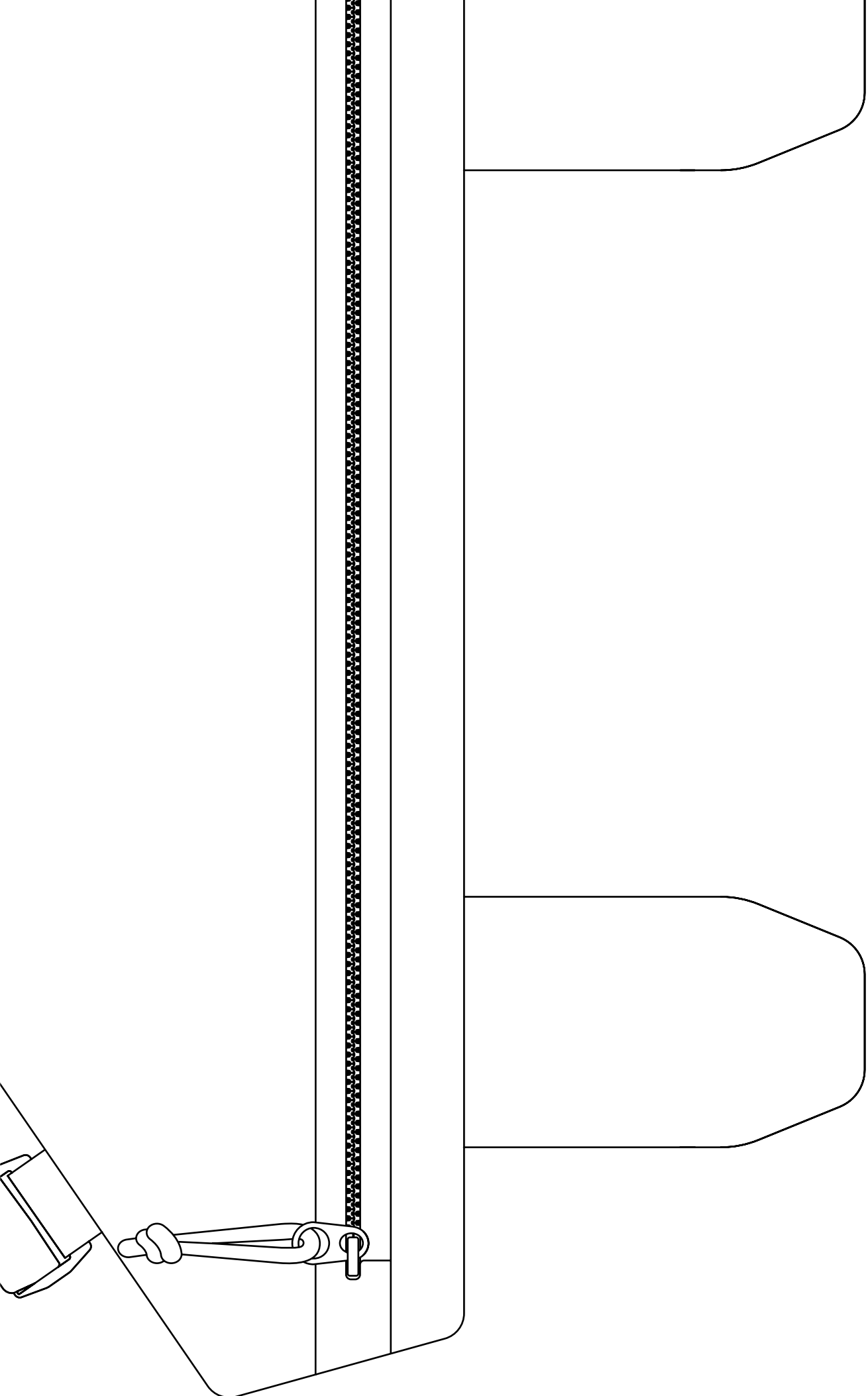

RESTRAP FRAME BAG - LARGE

